

3 Tonne Front Tip

KEY FEATURES & BENEFITS - MACH2081

Hydrostatic
TRANSMISSION



The Thwaites 3 Tonne Front Tip, Stage V dumper is manufactured with contractors and hirers in mind – ensuring operator safety, reducing risk on site and improving performance. Powered by an 18.4 kW 3-cylinder Yanmar engine, delivering 107 Nm max torque for optimum traction and control, this machine is driven by a Hydrostatic transmission, making it simple and straightforward to operate.

Thwaites 3 Tonne machines are available in a range of configurations to suit your needs including:

- › Hi Swivel
- › Power Swivel

Robust and reliable, this machine has a fully welded 5 mm steel plate skip with reinforced box section fitted to minimise skip damage.

Each dumper is supplied as standard with a Spring Activated Hydraulic Release (SAHR) Handbrake, ROPS frame, towing bracket reverse alarm and LED beacons. Full LED road lights including daylight running lights can be fitted as an optional extra.

Easy to service and maintain with market leading residuals.

Safe, compliant and competitive.

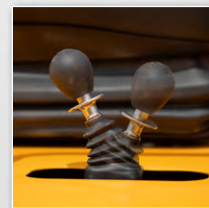

Thwaites

Thwaites Ltd, Leamington Spa,
Warwickshire, CV32 7NQ, England
Tel +44 (0)1926 422471

www.thwaitesdumpers.co.uk



Snap this QR code
from your smart
phone for more
information



GET THE JOB DONE.

3 Tonne Front Tip

DIMENSIONS & SPECIFICATIONS - MACH2081

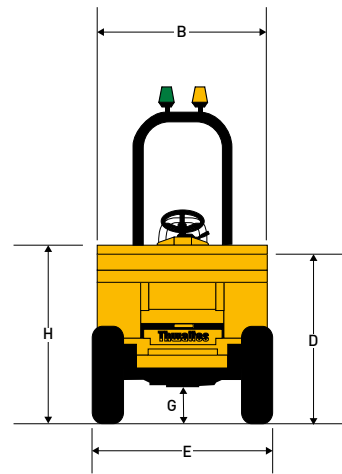
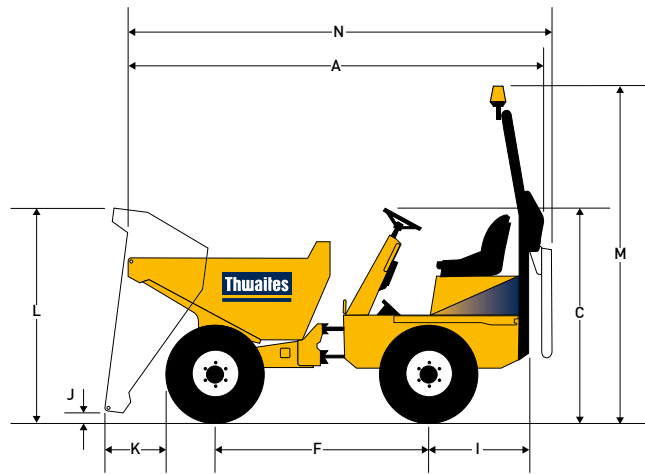

(mm)

A	3785
B	1650
C	1981
D	1381
E	1650
F	1950
G	337
H	1524
I	1042
J	321
K	603
L	2131
M	3108
N	3950

Weight	Unladen	2080 kg
	Shipping	2064 kg

Capacities	Max safe load	3000 kg
	Heaped	1680 litres
	Struck	1350 litres
	Water	1060 litres

Engine

- › Yanmar 3TNV88-BWWA, water-cooled, 3-cylinder water cooled direct-injection diesel
- › Power 18.4 kW/24.6 bhp at 2000 rpm
- › Torque 107 Nm (78.9 lbf ft)

Noise Levels

- › Operator's ear 84 LpA / airborne level 101 LwA

Transmission

- › Hydrostatic with high/low speed range, column mounted directional control lever and inching facility

Speeds	Forward and Reverse	
	Low	0-6.1 km/h (3.8 mph)
	High	0-16.1 km/h (10.0 mph)

Brakes and Axles

- › Totally enclosed multiplate oil-immersed discs mounted on rear axle & auto wear adjustment
- › Hand operated parking brake (SAHR)

Kinglink Chassis

- › Constructed from folded steel plate, with three point Kinglink giving articulation and oscillation for better stability, traction and safety on site

Skip

- › Hydraulically operated, 5 mm steel plate all round
- › Skip mouth & sides reinforced with box sections

Seating & Controls

- › Adjustable suspension seat with high-vis seat belt
- › LED warning lights for all critical functions

Service Access

- › Lockable engine cover for ground level service points
- › Diesel and hydraulic tanks positioned low permitting access to the filler caps

Electrics

- › Wiring harness contained within conduits and all electrical components water resistant to IP65/67 standards.

Steering and Hydraulics

- › Hydraulic power steering
- › Return line filtration for all services
- › Hydraulic test point fitted as standard

Tank Capacities	Fuel	24.5 litres
	Hydraulic	25.0 litres

Turning Circle	9.2m
-----------------------	------

Standard Equipment

- › LED beacons
- › Towing bracket
- › Reverse alarm

Optional Equipment

- › Full LED road lighting incl. DRL (Daylight Running Lights)
- › Road mirrors
- › Wheel nut indicator

Thwaites

Thwaites Ltd, Leamington Spa,
Warwickshire, CV32 7NQ, England
Tel +44 (0)1926 422471

www.thwaitesdumpers.co.uk



Images are representative, but specific details or equipment may vary by country. We reserve the right to change any and all specifications without prior notice. 08/2021